

BATHTUB SHOWER SCREEN INSTALLATION INSTRUCTION

317131-HD-PC/MB

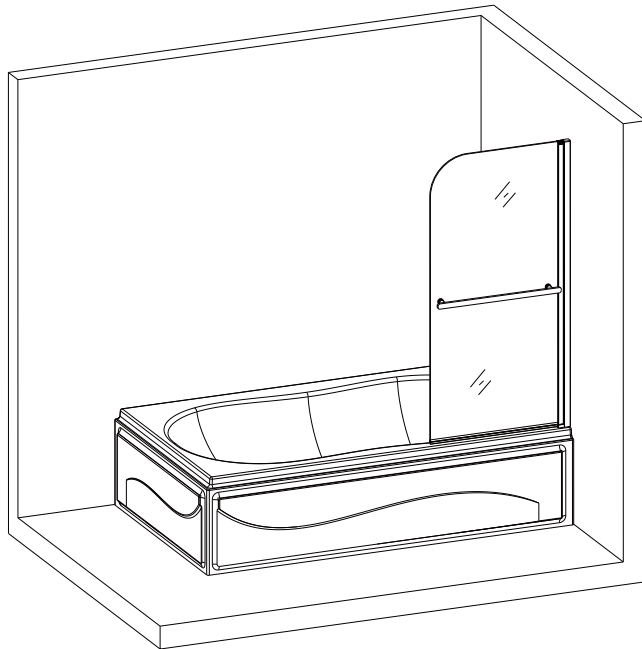

IMPORTANT-Please read and follow all warnings and instructions before using this product. Injury can result from improper use. Save this documents.



WARNING
Tempered Glass, please don't hit the corners and the surrounding, otherwise the glass will burst.

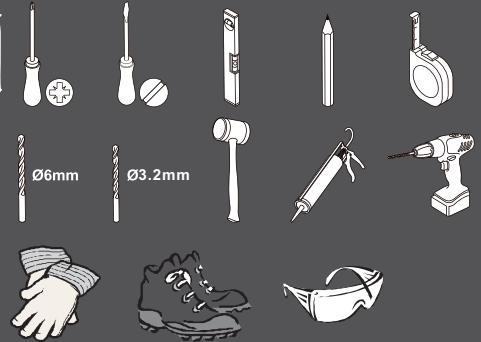

● General Information

Please inspect the product immediately upon receipt for transit damage, missing packs/parts or manufacturing fault. Damage reported later cannot be accepted. Please handle the product with care avoiding knocks and shock loading to all sides and edges of the glass.

Notes: Safety glass can not be re-worked.

Please read these instructions carefully before start of installation.

Special care should be taken when drilling walls to avoid hidden pipes or electrical cables.

Note: This product is heavy and may require two people to install.

Aftercare instructions

After use, your shower should be cleaned with soap and water. This is particularly important in hard water districts where insoluble lime salts may be deposited and allowed to build up. Cleaners of a gritty or abrasive nature should not be used. Care should be taken to avoid contact with strong chemicals such as organic solvents and strippers.

Glass cleaners can be used but with caution, if in doubt contact the manufacturer of the cleaner in question.

Please keep these instructions for aftercare and customer service details.

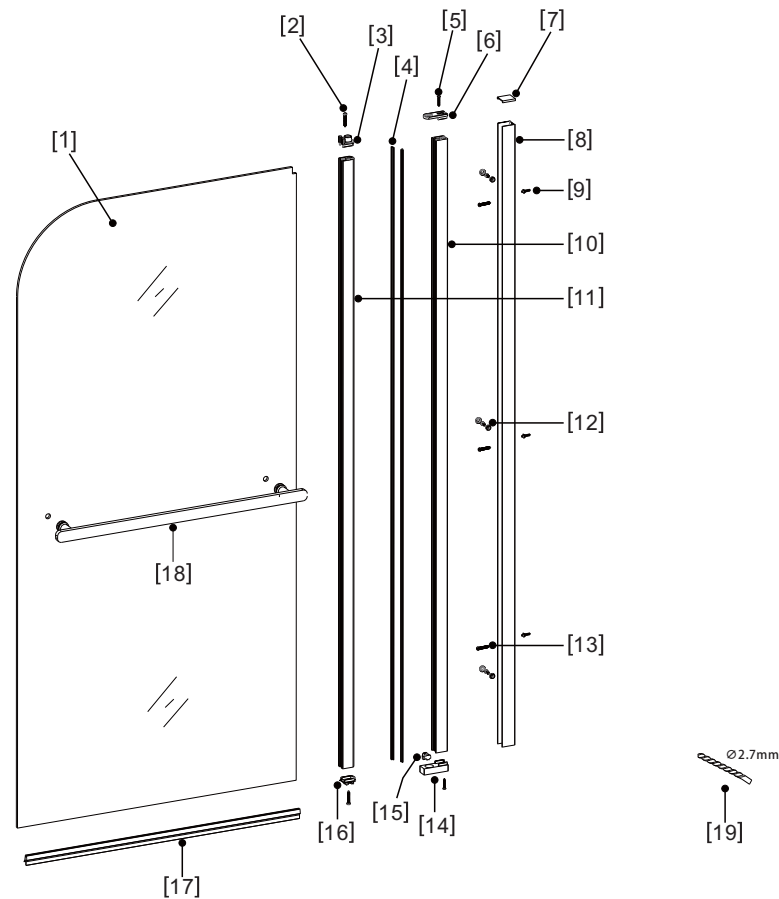

- | | |
|-------------------------------|-----------------------------------|
| [1] 1X Door Panel | [10] 1X Vertical Profile |
| [2] 2X Screw ST4X25 | [11] 1X Pivot Profile |
| [3] 1X Upper Pivot Base | [12] 3X Screw Cap+Screw ST3,5X10 |
| [4] 2X Water-Proof Gasket | [13] 3X Screw ST4X30 |
| [5] 2X Screw ST4X25 | [14] 1X Bottom Pivot Base |
| [6] 1X Upper Pivot Sleeve | [15] 1X Elevator parts |
| [7] 1X Vertical Profile Cover | [16] 1X Bottom Pivot Sleeve |
| [8] 1X Wall Profile | [17] 1X Bottom Water-Proof Gasket |
| [9] 3X Wall Anchor | [18] 1X Towel Bar |
| | [19] 1X Drill bits |



● Box Contents:

[1] 1X Door Panel	➔	
[2] 2X Screw ST4X25	➔	
[3] 1X Upper Pivot Base	➔	
[4] 2X Water-Proof Gasket	➔	
[5] 2X Screw ST4X25	➔	
[6] 1X Upper Pivot Sleeve	➔	
[7] 1X Vertical Profile Cover	➔	
[8] 1X Wall Profile	➔	
[9] 3X Wall Anchor	➔	
[10] 1X Vertical Profile	➔	
[11] 1X Pivot Profile	➔	
[12] 3X Screw Cap Screw ST3,5X10	➔	
[13] 3X Screw ST4X30	➔	
[14] 1X Bottom Pivot Base	➔	
[15] 1X Elevator parts	➔	
[16] 1X Bottom Pivot Sleeve	➔	
[17] 1X Bottom Water-Proof Gasket	➔	
[18] 1X Towel Bar	➔	
[19] 1X Drill bits	➔	



● Assembly

01



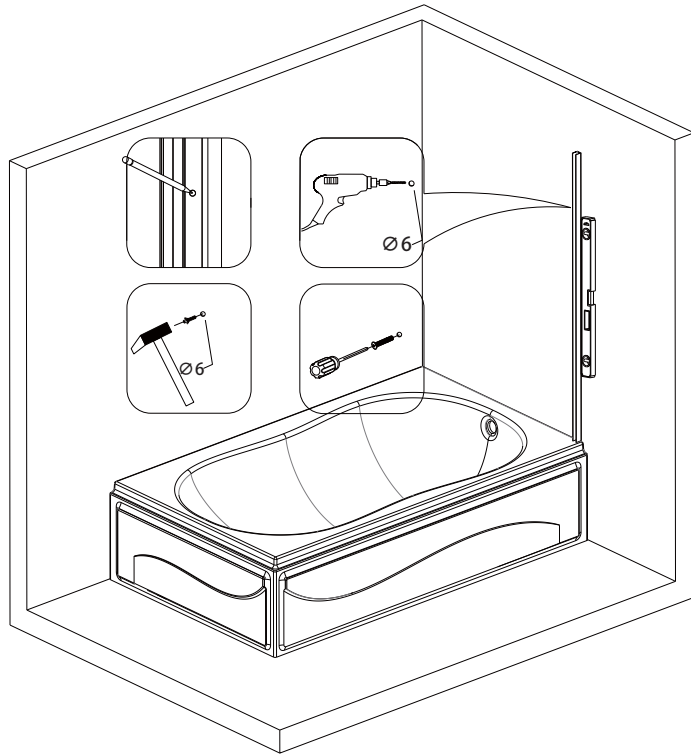

[8]	 1X
[9]	 3X
[13]	 3X ST4X30

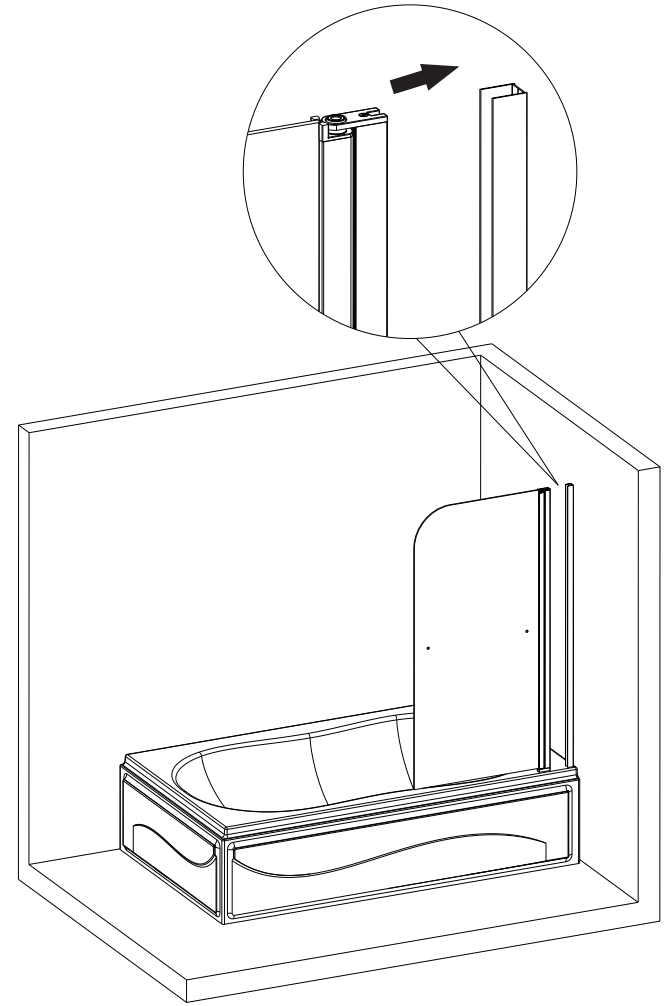

02

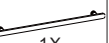

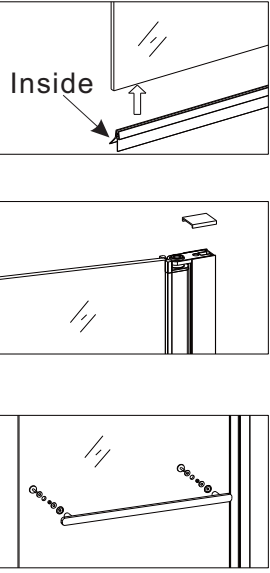
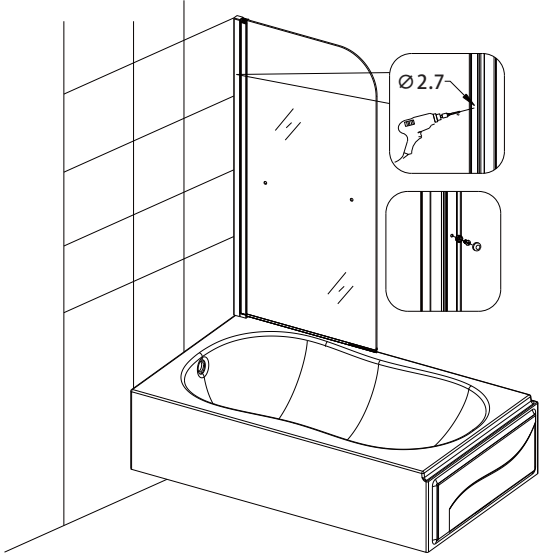

03

[19]	 Ø2.7mm
[18]	 1X
[12]	 3X
[7]	 1X
[17]	 1X

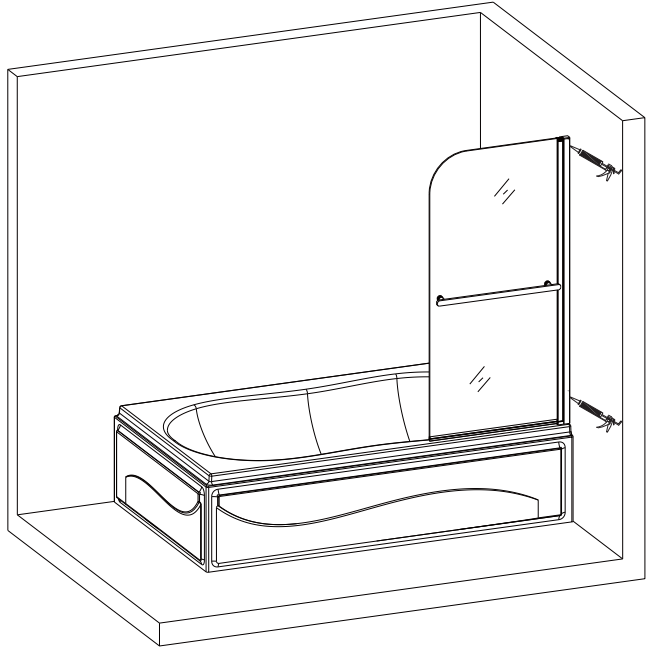

04



 Please ensure the bottom horizontal is straight before the silicone sealant to cure fully

● Do not use the shower enclosure for at least 24 hour in order to allow the silicone sealant to cure fully.